

BOSS®



ZONE:1

**Mobile Fibreglass Tower
1450/850 Ladderspan**

3T - Through the Trapdoor Method

Instruction Manual
EN 1004-2 en

Contents

1 Safety First

1.1	Introduction	2
1.2	Tower Designation	3
1.3	Maintenance - Storage - Transport	3

2 Building the Tower

2.1	Pre-Assembly Checks	4
2.2	Component Diagram	6
2.3	Quantity Schedule	8
2.4	Stabilisers	10
2.5	Assembly	11
2.5.1	Assembly General: Steps 1 to 3	13
2.5.2	Assembly For 1450 Towers: Steps 4 to 7	14
2.5.3	Assembly For 850 Towers: Steps 4 to 9	16
2.6	Dismantling	18

3 Using the Tower

3.1	Safety Checklist	19
3.2	Pre-Use Checklist	19
3.3	Use	20
3.4	Movement of the Assembled Prefabricated Tower Scaffold	22

1 Safety First

1.1 Introduction

Please read this instruction manual carefully.

This instruction manual shall be available at the location of use of this mobile access tower. Instruction manuals are also available to download at www.bossaccesstowers.com.



This product shall only be used in accordance with this manual without any modification.



FAILURE TO FOLLOW THESE INSTRUCTIONS MAY LEAD TO DEATH OR SERIOUS INJURY.

Mobile access towers must always be used in accordance with the national regulations. If any aspect of these instructions conflicts with local regulations, please contact Werner UK Sales & Distribution Ltd. for advice.

Please note that diagrams are for illustrative purposes only.

User training courses are available but must not be used as a substitute for familiarity with this manual.

A BoSS Zone:1 fibreglass mobile access tower is a safe and practical alternative when other towers are not suitable for use, especially around electricity. They provide indoor and outdoor access solutions where a stable and secure platform is required. Ideal for maintenance and installation work or short-term access, the highly versatile towers provide a strong working platform for a variety of heights.

Verification and assessment documentation is held by Werner UK Sales & Distribution Ltd.

1 Safety First

1.2 Tower Designation

3 8/12 XXXD H2

Load Class (2 = 153kg/m² UDL, 3 = 204kg/m² UDL*)

Max. Platform Height Outdoors (m)

Max. Platform Height Indoors (m)

Access Method

A = Stairway, B = Stair ladder, C = Inclined Ladder, D = Vertical Ladder

Clear Height Class (H1 = 1.85m, H2 = 1.90m)

*UDL = Uniformly distributed load

1.3 Maintenance - Storage - Transport

- The BoSS mobile tower system is robust and requires little maintenance.
- All components and their parts should be regularly inspected to identify damage, particularly to joints.
- Refer to the BoSS Fibreglass Tower Inspection Guidance for detailed inspection and maintenance advice, the guidance is available to download at: www.bossacesstowers.com.
- Threads, hinges, and brace latches may be lubricated with light oil. Ensure oil does not contaminate climbing or walking surfaces.
- Safety labels should be kept legible. Replacement labels are available from Werner UK Sales & Distribution Ltd.
- Surfaces should be kept reasonably free of dried paint, plaster etc.
- Use of solvents on wooden platform surfaces and plastic components should be avoided.
- Components should be stored in clean, dry conditions with due care to prevent damage.
- During transportation ensure components are not damaged by excessive strapping forces.

2 Building the Tower

2.1 Pre-Assembly Checks

- Check overhead that the area into which the structure is to be erected contains no obstructions, particularly electrical or radio radiation hazards.
- Ensure the ground on which the mobile access tower is to be erected is capable of supporting the tower in use.
- Check the surface is level within the 315mm range of the adjustable legs.
- Only components specified in this manual shall be used with BoSS Zone:1 towers. Check all required components are onsite and in a suitable working condition.
- Damaged components shall not be used and must be put beyond use and disposed of according to local regulations.
- Adjustable legs should only be used for levelling purposes and never to gain extra height.
- Ensure distance from the ground to first climbing rung is less than 400mm.
- Only climb the tower from the inside using the access method provided.

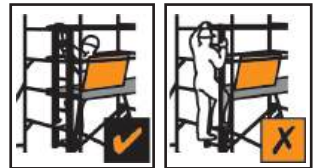

- This tower provides a work platform. It must not be used to access other structures.

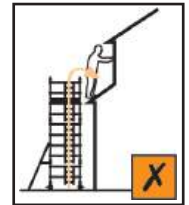

- Tower scaffolds are not designed to be lifted or suspended.
- Ensure the safe working load on the structure is not exceeded.
- Tools and materials should be lifted using a reliable lifting material (e.g. a strong rope) employing a reliable knot (e.g. clove hitch) to ensure safe fastening and always lift within the footprint of the prefabricated tower scaffold (i.e. within the area bounded by the stabilisers).

2 Building the Tower

- Check this manual is available and its contents familiar to all those involved.
- If assembling outdoors; check the forecast windspeed.
 - The assembled tower is certified to wind forces equating to 27mph, but handling components under those conditions would be hazardous.



- Also consider the wind funnelling effect of nearby buildings.



- Towers greater than 8.2m platform height are for indoor use only.
- Consideration should be given to potential wind conditions if the tower is left unattended.

2 Building the Tower

2.2 Component Diagram

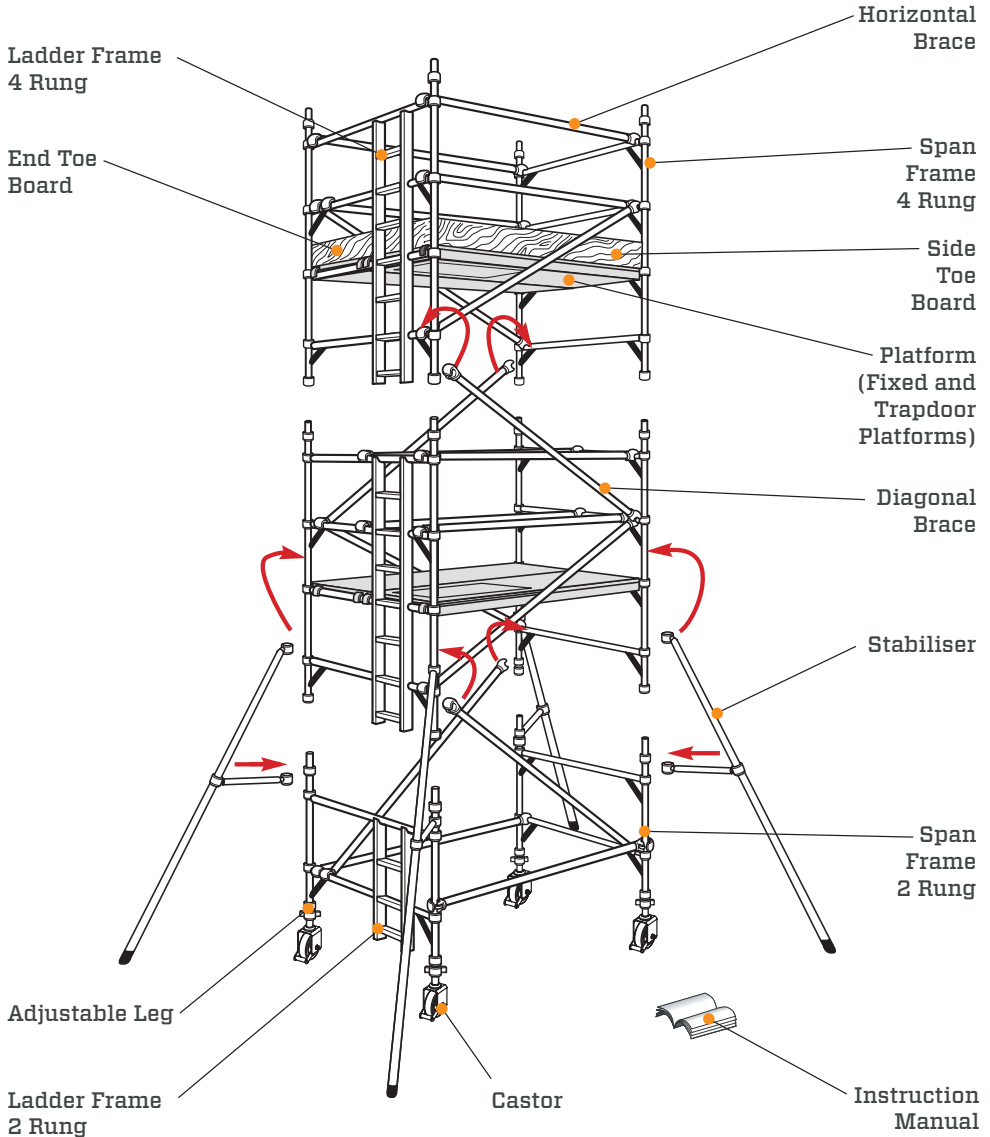

2 Building the Tower

Component Weights

Component		
Code	Name	Weight (kgs)
32842300	Castor 150mm	3.3
32942300	Castor 125mm	3.0
33351300	Castor 200mm	4.0
35754300	Adjustable leg	1.1
31254300	Ladder Frame 850 2 Rung	9.1
30954300	Span Frame 850 2 Rung	3.5
31154300	Ladder Frame 850 3 Rung	10.4
30854300	Span Frame 850 3 Rung	5.0
31054300	Ladder Frame 850 4 Rung	11.7
30754300	Span Frame 850 4 Rung	6.6
30654300	Ladder Frame 1450 2 Rung	12.6
30354300	Span Frame 1450 2 Rung	6.7
30554300	Ladder Frame 1450 3 Rung	15.1
30254300	Span Frame 1450 3 Rung	9.5
30454300	Ladder Frame 1450 4 Rung	17.6
30154300	Span Frame 1450 4 Rung	12.2
32354300	Fixed Platform 1.8m	17.0
32254300	Fixed Platform 2.5m	23.0
32654300	Trapdoor Platform 1.8m	19.0
32554300	Trapdoor Platform 2.5m	25.0
34654300	Horizontal Brace 1.8m (red)	2.0
34554300	Horizontal Brace 2.5m (red)	2.5
34354300	Diagonal Brace 2.1m (blue)	2.3
34254300	Diagonal Brace 2.7m (blue)	2.6
33154300	Side Toe Board 1.8m	3.2
32254300	Side Toe Board 2.5m	4.4
33554300	End Toe Board 0.6m	1.0
33454300	End Toe Board 1.45m	2.1
35254300	Small Stabiliser	4.7
35354300	Large Stabiliser	5.5

2.3 Quantity Schedule

BoSS 1450 Zone:1 : Available in 2 lengths - 1.8m and 2.5m

Component		Internal or External Use										Internal Use																		
		Working Height (m)	3.2	3.7	4.2	4.7	5.2	5.7	6.2	6.7	7.2	7.7	8.2	8.7	9.2	9.7	10.2	10.7	11.2	11.7	12.2	12.7	13.2	13.7	14.2					
Code	Name	Platform Height (m)	1.2	1.7	2.2	2.7	3.2	3.7	4.2	4.7	5.2	5.7	6.2	6.7	7.2	7.7	8.2	8.7	9.2	9.7	10.2	10.7	11.2	11.7	12.2	12.7	13.2	13.7	14.2	
33351300/ 32842300/ 32942300	Castor 12.5mm/150mm 200mm		4	4	4	4	4	4	4	4	4	4	4	4	4	4	4	4	4	4	4	4	4	4	4	4	4	4	4	4
35754300	Adjustable Leg		4	4	4	4	4	4	4	4	4	4	4	4	4	4	4	4	4	4	4	4	4	4	4	4	4	4	4	4
30654300	Ladder Frame 1450 2 Rung		-	1	1	-	1	1	-	1	1	-	1	1	-	1	1	-	1	1	-	1	1	-	1	1	-	1	1	1
30354300	Span Frame 1450 2 Rung		-	1	1	-	1	1	-	1	1	-	1	1	-	1	1	-	1	1	-	1	1	-	1	1	-	1	1	1
30554300	Ladder Frame 1450 3 Rung		-	1	-	1	-	1	-	1	-	1	-	1	-	1	-	1	-	1	-	1	-	1	-	1	-	1	-	1
30254300	Span Frame 1450 3 Rung		-	1	-	1	-	1	-	1	-	1	-	1	-	1	-	1	-	1	-	1	-	1	-	1	-	1	-	1
30454300	Ladder Frame 1450 4 Rung		1	-	1	1	2	1	2	2	3	2	3	3	4	3	4	4	4	5	4	4	5	4	5	4	5	6	5	6
30154300	Span Frame 1450 4 Rung		1	-	1	1	2	1	2	2	3	2	3	3	4	3	4	4	4	5	4	4	5	4	5	4	5	6	5	6
32354300/ 32254300	Fixed Platform 1.8m and 2.5m		1	1	1	2	2	2	2	3	3	3	3	4	4	4	4	4	4	3	3	3	3	3	3	3	4	4	4	4
32654300/ 32554300	Trapdoor Platform 1.8m and 2.5m		1	1	1	1	2	2	2	2	3	3	3	3	4	4	4	4	4	3	3	3	3	3	3	3	4	4	4	4
34654300/ 34554300	Horizontal Brace 1.8m and 2.5m (red)		6	6	6	6	10	10	10	10	14	14	14	14	14	18	18	18	18	18	18	18	18	22	22	22	22	26	26	26
34354300/ 34254300	Diagonal Brace 2.1m and 2.7m (blue)		2	3	3	4	5	6	7	8	9	10	11	12	13	14	15	15	16	16	17	17	18	19	20	21	22	23	23	23
33154300/ 33354300	Side Toe Board 1.8m and 2.5m		2	2	2	2	2	2	2	2	2	2	2	2	2	2	2	2	2	2	2	2	2	2	2	2	2	2	2	2
33454300	End Toe Board 1.45m		2	2	2	2	2	2	2	2	2	2	2	2	2	2	2	2	2	2	2	2	2	2	2	2	2	2	2	2
35254300	Small Stabiliser		-	-	-	4	4	4	4	4	4	-	-	-	-	-	-	-	-	-	-	-	-	-	-	-	-	-	-	-
35354300	Large Stabiliser		-	-	-	-	-	-	-	-	-	-	4	4	4	4	4	4	4	4	4	4	4	4	4	4	4	4	4	4
Tower Total Self-weight 1.8m (kgs)			112	128	133	177	211	228	235	260	294	311	321	346	380	397	404	376	391	408	415	440	474	491	498	498	498	498	498	498
Tower Total Self-weight 2.5m (kgs)			130	146	152	201	244	261	269	300	342	359	370	401	444	460	468	428	446	463	471	501	544	561	561	561	561	561	561	561

BoSS 850 Zone:1 : Available in 2 lengths - 1.8m and 2.5m

Component		Internal or External Use										Internal Use																	
		Working Height (m)	Platform Height (m)	3.2	3.7	4.2	4.7	5.2	5.7	6.2	6.7	7.2	7.7	8.2	8.7	9.2	9.7	10.2	10.7	11.2	11.7	12.2	12.7	13.2	13.7	14.2			
Code	Name	1.2	1.7	2.2	2.7	3.2	3.7	4.2	4.7	5.2	5.7	6.2	6.7	7.2	7.7	8.2	8.7	9.2	9.7	10.2	10.7	11.2	11.7	12.2	12.7	13.2	13.7	14.2	
33351300/ 32842300/ 32942300	Castor 125mm/150mm 200mm	4	4	4	4	4	4	4	4	4	4	4	4	4	4	4	4	4	4	4	4	4	4	4	4	4	4	4	4
36754300	Adjustable Leg	4	4	4	4	4	4	4	4	4	4	4	4	4	4	4	4	4	4	4	4	4	4	4	4	4	4	4	4
31254300	Ladder Frame 850 2 Rung	-	1	1	-	-	1	1	-	-	1	1	-	-	1	1	-	-	1	1	-	-	1	1	-	-	1	1	1
30954300	Span Frame 850 2 Rung	-	1	1	-	-	1	1	-	-	1	1	-	-	1	1	-	-	1	1	-	-	1	1	-	-	1	1	1
31154300	Ladder Frame 850 3 Rung	-	1	-	1	-	1	-	1	-	1	-	1	-	1	-	1	-	1	-	1	-	1	-	1	-	1	-	1
30854300	Span Frame 850 3 Rung	-	1	-	1	-	1	-	1	-	1	-	1	-	1	-	1	-	1	-	1	-	1	-	1	-	1	-	1
31054300	Ladder Frame 850 4 Rung	1	-	1	1	2	1	2	2	3	2	3	3	4	3	4	4	5	4	4	5	4	5	4	5	6	5	6	6
30754300	Span Frame 850 4 Rung	1	-	1	1	2	1	2	2	3	2	3	3	4	3	4	4	5	4	4	5	4	5	4	5	6	5	6	6
32354300/ 32254300	Fixed Platform 1.8m and 2.5m	-	-	-	-	-	-	-	-	-	-	-	-	-	-	-	-	-	-	-	-	-	-	-	-	-	-	-	-
32654300/ 32554300	Trapdoor Platform 1.8m and 2.5m	1	1	1	2	2	2	2	3	3	3	3	4	4	4	4	4	5	5	5	6	6	6	6	6	6	6	6	6
34654300/ 34554300	Horizontal Brace 1.8m and 2.5m (red)	6	6	6	6	10	10	10	14	14	14	14	14	14	18	18	18	18	22	22	22	22	22	22	22	22	26	26	26
34354300/ 34254300	Diagonal Brace 2.1m and 2.7m (blue)	2	3	3	4	5	6	7	8	9	10	11	12	13	14	15	16	17	18	19	20	21	22	22	22	26	26	26	26
33154300/ 33354300	Side Toe Board 1.8m and 2.5m	2	2	2	2	2	2	2	2	2	2	2	2	2	2	2	2	2	2	2	2	2	2	2	2	2	2	2	2
33554300	End Toe Board 0.6m	2	2	2	2	2	2	2	2	2	2	2	2	2	2	2	2	2	2	2	2	2	2	2	2	2	2	2	2
35254300	Small Stabiliser	-	-	4	4	4	4	4	-	-	-	-	-	-	-	-	-	-	-	-	-	-	-	-	-	-	-	-	-
35354300	Large Stabiliser	-	-	-	-	-	-	-	4	4	4	4	4	4	4	4	4	4	4	4	4	4	4	4	4	4	4	4	4
Tower Total Self-weight 1.8m (kgs)		80	92	113	138	151	163	168	195	208	220	226	250	263	275	280	304	317	329	335	359	372	384	389	389	389	389	389	389
Tower Total Self-weight 2.5m (kgs)		92	104	126	156	172	184	189	223	239	251	256	287	327	365	395	350	366	378	384	414	430	442	447	447	447	447	447	447

2 Building the Tower

Assembly Variations

This section lists the permitted component variation from the Quantity Schedule.

Note: These substitutions must be made before assembly.

Castors

Other Castor sizes and types may be substituted:

Component Code	Description	Weight (kg)
31842300	Diameter 150mm (Tyred)	3.2
32942300	Diameter 200mm	3.9
31942300	Diameter 200mm (Tyred)	3.9

2.4 Stabilisers

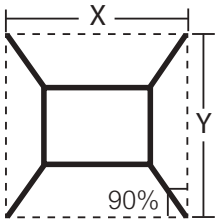

	Double Width 1450 Tower				Single Width 850 Tower			
	1.8m		2.5m		1.8m		2.5m	
	X	Y	X	Y	X	Y	X	Y
Small Stabiliser	4330	3868	4918	3868	4330	3268	4918	3268
Large Stabiliser	4998	4536	5586	4536	4082	4629	4650	4650

Telescopic stabilisers must always be fully extended.

Position the lower clamp so that the arm is as close to horizontal as possible. Adjust the position of the top clamp to ensure the stabiliser foot is in firm contact with the ground. Ensure the clamps are secure.

2 Building the Tower

2.5 Assembly

This tower structure must be assembled, and components oriented, in accordance with this instruction manual. Deviation from this instruction manual is not permitted.



THIS TOWER MUST NOT BE USED AS AN ANCHOR POINT FOR PERSONAL FALL PROTECTION EQUIPMENT.

- No tools are required for assembly.
- The assembly uses the 3T (Through the Trapdoor) method that provides collective fall protection.
 - From the sitting position in the trapdoor opening fit all guardrails before standing on the platform.
 - Fit braces in the locations described and ensure the claws are locked.

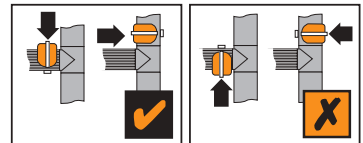

- DO NOT stand on an unprotected platform



- The tower may be assembled by a single person, but it is recommended that two or more are used to pass up components on the taller assemblies.
- Components must be lifted within the footprint of the tower using a reliable method such as a strong rope with a clove hitch knot.
- Castor brakes should be locked as soon as the tower base is in position.
- The tower base should be levelled to within 0.6° before continuing the assembly.
- The adjustable legs are for levelling the tower only and not to be used to gain extra height.
- Ensure when the base is levelled the distance from the ground to the first climbing rung is less than 400mm.
- Stabilisers of the size specified in the quantity schedule should be fitted at the earliest opportunity.

2 Building the Tower

- Always start assembly with the smallest end frames at the base.

Platform Height (m)	Frame at Base
1.7, 2.2, 3.7, 4.2, 5.7, 6.2, 7.7, 9.7, 10.2, 11.7, 12.2	2 Rung
2.7, 4.7, 6.7, 8.7, 10.7	3 Rung
1.2, 3.2, 5.2, 7.2, 9.2, 11.2	4 Rung

- Where all three frames are specified, start with the 2 rung, 3 rung next and 4 rung on top. Refer to the quantity schedule for details.

Platform heights:

1.2m, 3.2m, 5.2m, 7.2m, 9.2m, 11.2m

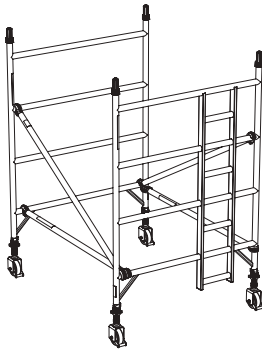

Platform heights:

2.2m, 4.2m, 6.2m, 8.2m, 10.2m, 12.2m

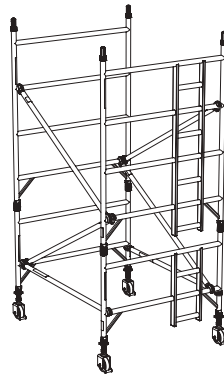

Platform heights:

1.7m, 3.7m, 5.7m, 9.7m, 11.7m

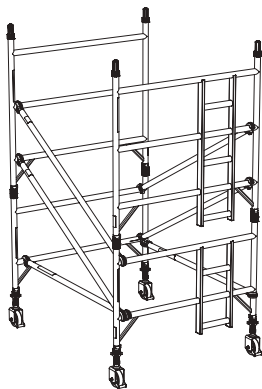

Platform heights:

2.7m, 4.7m, 6.7m, 8.7m, 10.7m, 12.7m

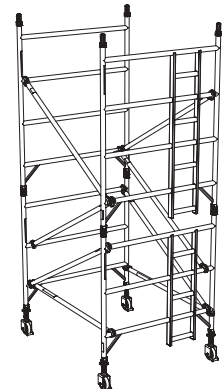

2 Building the Tower

2.5.1 Assembly General

1 Push castor into adjustable leg. Push castor/adjustable leg assemblies into a span frame. Lock castors. Repeat procedure with a ladder frame.

It is recommended that for ease of levelling a gap of 50mm is left between the bottom of the leg and the adjustable nut.

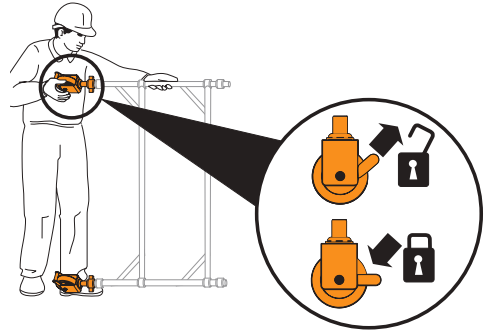

2 Fit one horizontal brace (red) onto the vertical of a span frame, just above the bottom rung, with the claw facing outwards. The frame will now be self-supporting.

All locking claws must be opened before fitting.

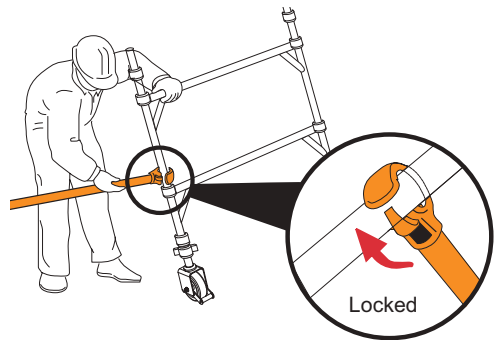

3 Position the ladder frame as shown and fit the other end of the horizontal brace on to the vertical (just above the bottom rung).

Fit a second horizontal brace between the bottom rungs on the other side of the frames to square the tower.

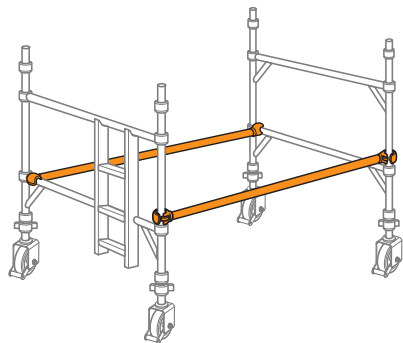

Assembly for 1450 towers, see page 14 for following steps.
Assembly for 850 towers, see page 16 for following steps.

2 Building the Tower

2.5.2 Assembly For 1450 Towers

The procedure illustrated shows a 4.2m platform height tower starting with a 2 rung end frame.

4 Fit two additional end frames, ensuring the frame interlock clips are engaged.

Fit two diagonal braces (blue) in opposite directions between the 1st and 3rd rungs.

Ensure the frames are vertical and level by checking with a spirit level and setting the adjustable legs as required.

Fit stabilisers (see notes on page 10).

Only use the adjustment on the legs to level the tower and not to gain extra height.

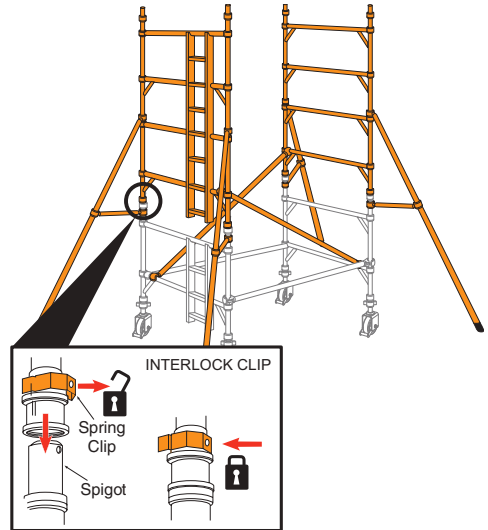

5 Fit the next pair of diagonal braces in opposite directions between the 3rd and 5th rungs. Fit a trapdoor platform on the 4th rung (2.0m) with the trapdoor next to the ladder. Ensure the trapdoor is positioned with the hinges towards the outside of the tower as shown. Fit a fixed platform alongside it.

Climb the ladder from the protected trapdoor position, fit the horizontal braces on the 5th and 6th rungs (in that order) on both sides of the platform.

When horizontal braces are fitted as guardrails, they should be 0.5m and 1.0m (1 and 2 rungs) above the platform level in all cases.

Do not climb onto the platform until all guardrails are in place.

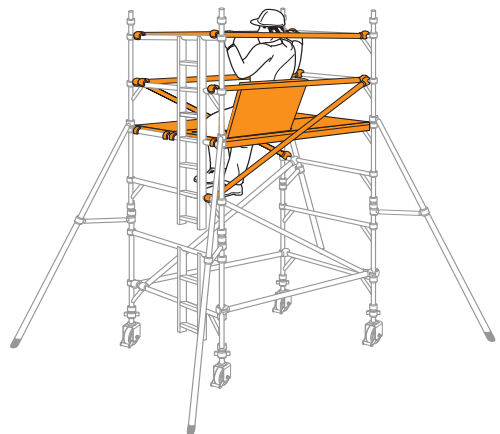

2 Building the Tower

6 Continue the procedure until the required height is reached, adding additional pairs of end frames, diagonal braces and fitting trapdoor and fixed platforms, as shown on previous steps. At every platform level, add horizontal braces as guardrails from the protected position within the trapdoor (as shown in **Step 5**).

At the required platform height, fit the fixed platform and a trapdoor platform alongside it. Fit the final guardrails (as shown in **Step 5**).

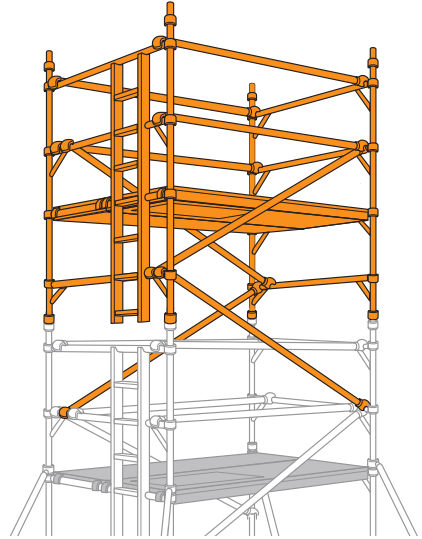

7 Fit toe boards.

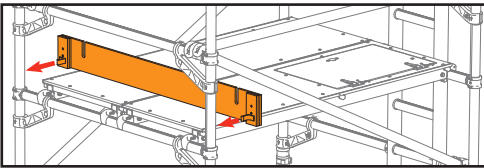

End toe board

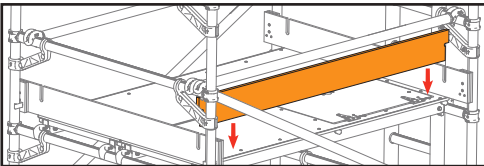

Side toe board

The tower is now complete.

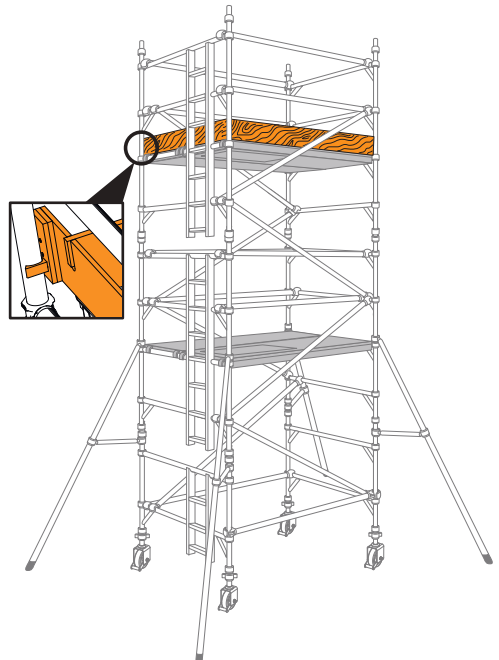

2 Building the Tower

2.5.3 Assembly For 850 Towers

The procedure illustrated shows a 3.2m platform height tower starting with a 4 rung end frame.

- 4** Fit a trapdoor platform on the 2nd rung. Fit the horizontal braces on both sides of the tower. When horizontal braces are fitted as guardrails, they should be 0.5m and 1.0m (1 and 2 rungs) above the platform level in all case.

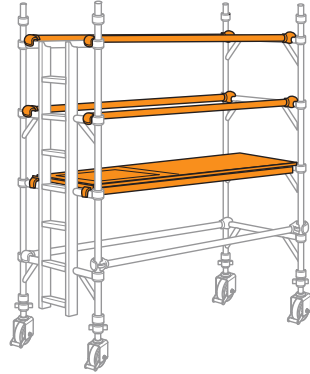

- 5** Fit two diagonal braces in opposite directions between the 1st and 3rd rungs.

Ensure that the frames are vertical and level by checking with a spirit level and setting the adjustable legs, as necessary.

Fit stabilisers (see notes on **page 10**).

Fit the next pair of end frames and check the frame interlock clips are engaged.

Only use the adjustment on the legs to level the tower and not to gain extra height.

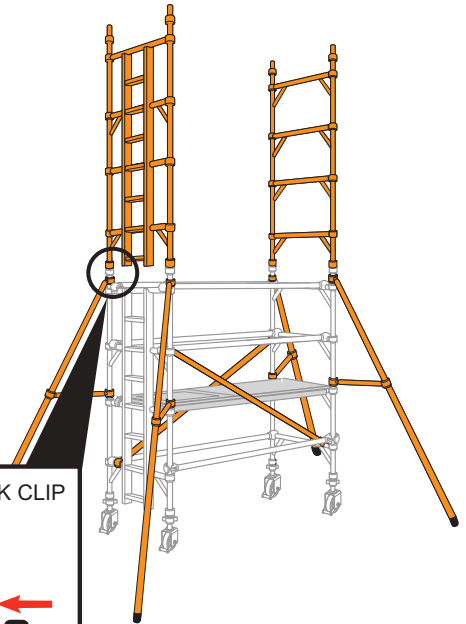
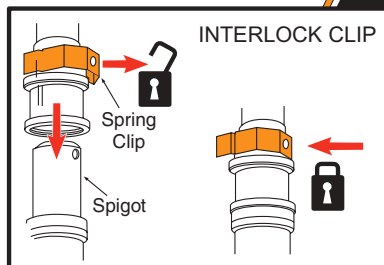

2 Building the Tower

6 Fit two pairs of diagonal braces in opposite directions between the 3rd and 5th rungs and the 5th and 7th rungs.

Locate a trapdoor platform on the 6th rung, with the trapdoor next to the ladder.

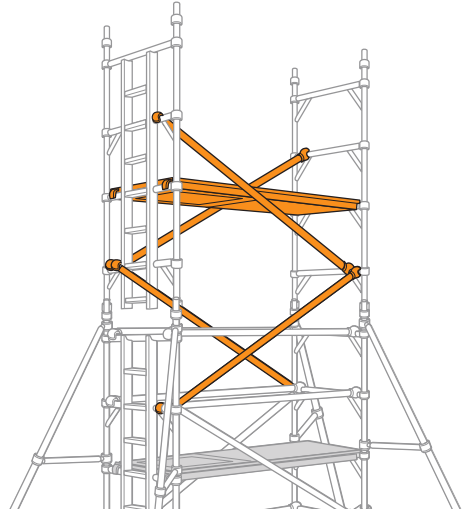

7 Climb up the inside of the tower and from protected position of the trapdoor, fit guardrails to the 7th and 8th rungs (in that order) on both sides of the tower.

Do not climb onto the platform until all guardrail are in place.

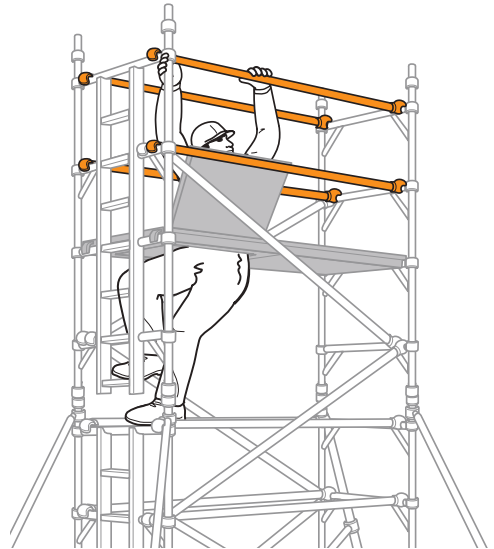

2 Building the Tower

8 Continue the procedure until the required height is reached, adding additional pairs of end frames, diagonal braces and fitting trapdoor platforms, as shown on previous steps. At every platform level, add horizontal braces as guardrails from the protected position within the trapdoor (as shown in **Step 7**).

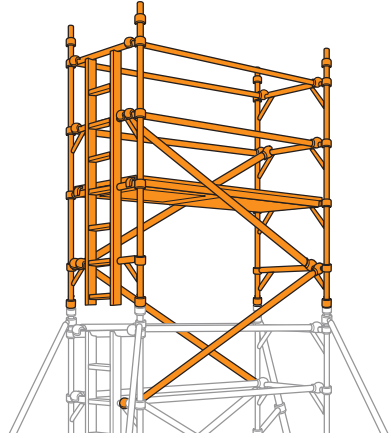

9 Fit toe boards.

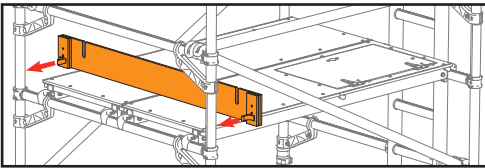

End toe board

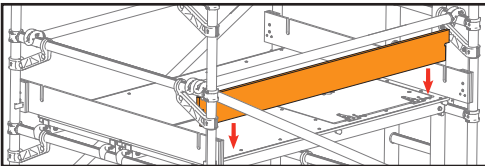

Side toe board

The tower is now complete.

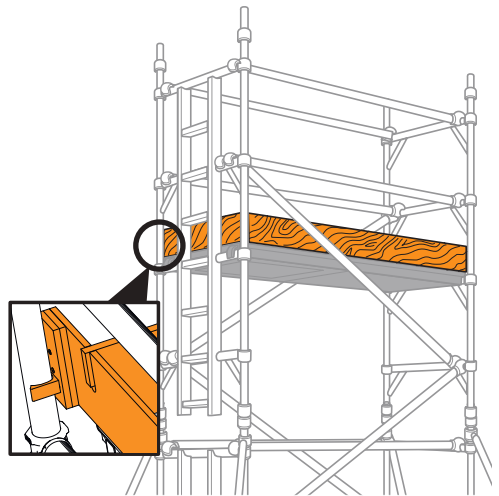

2.6 Dismantling

To dismantle the tower, reverse the assembly procedure.

When removing the guardrails unlock the four claws furthest from the trapdoor and return immediately to the protected position within the trapdoor. The other claws can then be unlocked, and the guardrails removed from the tower.











3 Using the Tower

3.1 Safety Checklist

This inspection must be carried out before initial use, after moving the tower, if any environmental condition change that may affect the tower and at regular intervals determined by local regulations.

Local regulations may also specify other information to be supplied to the user or attached to the structure. These regulations must be followed.

3.2 Pre-Use Checklist

Tower upright and level to within 0.6°	
Castor brakes locked and all wheels in ground contact	
All interlock clips engaged	
Braces/Guardrails correctly positioned	
All claws latched	
All platforms securely seated on rungs	
Correct stabiliser size fitted and positioned	
Toe boards fitted to working platform	
Instruction manual available to user	
No environment changes affecting safe use have occurred or are likely	
Tower is the correct height for intended use	

3 Using the Tower

3.3 Use

- This tower must not be used as an anchor point for personal fall arrest equipment.
- The tower must only be climbed on the inside, using the access method specified.

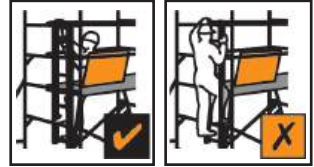

- This tower provides a work platform. It must not be used to access other structures.



- Raising and lowering tools and materials must only be conducted within the tower footprint.
- Only one platform at a time can be used as a working platform. Toe boards must be fitted to that platform.
- Ensure the safe working load on the structure is not exceeded. The number of people permitted on the tower at any time is limited by the safe working load.
 - 1.8m platform rated at 220kg UDL
 - 2.5m platform rated at 291kg UDL
- The adjustable legs are for levelling the tower only. They must not be used to gain extra height.
- Do not use boxes, stepladders or other objects to gain extra height.



- Beware of horizontal forces that might cause instability. Maximum horizontal force = 30kg.



3 Using the Tower

- Beware of high winds. This tower has been assessed as a freestanding structure for wind loads equating to 27mph (43kph, 12m/s). If greater windspeeds are forecast the tower must be moved to a sheltered location or dismantled while it is still safe to do so.



- Sheets, tarpaulins, or signage must not be attached to this tower outdoors.
- Towers above 8.2m platform height are for indoor use only.

3 Using the Tower

3.4 Movement of the Assembled Prefabricated Tower Scaffold



MOVING A FULLY ASSEMBLED TOWER CAN BE EXTREMELY HAZARDOUS.

If there is any doubt about the safety of the move, the tower must be dismantled and reassembled in the new location.

This tower is not designed to be lifted or suspended.

Ensure gloves or other suitable hand protection is worn.

Before

- Beware of rough, sloping ground and high winds. Tower stability is improved by reducing height.
- Survey the route to be taken. Assess the ground condition/slope and any overhead obstructions or hazards and wind conditions.
- Ensure there are no persons, tools, or materials on the tower.
- Release the castor brakes.
- Release the stabiliser top clamp to allow the feet to be raised a maximum of 25mm. Re-tighten the clamps.

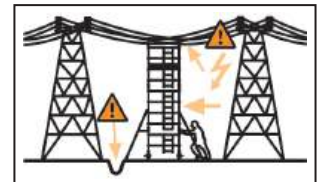

3 Using the Tower

During

- The tower must be moved only by manual effort, pushing at the base of the tower.
- Constant attention must be given to the position of the castors, stabiliser feet and the top of the tower.
- If there is any resistance to movement, stop and investigate the reason before continuing.

After

- As soon as the move is complete; lock the castor brakes, lower the stabiliser feet, and perform the pre-use inspection.



For further information and support for the Zone:1 or any other products, design advice and services, please contact:

Werner UK Sales & Distribution Ltd.
Blackwater Trading Estate,
The Causeway, Maldon,
Essex, CM9 4LJ,
United Kingdom

WernerCo Hungary Kft.
6000 Kecskemét,
Szt. Istvan Krt. 19.

☎ +44 (0)1621 745900

✉ uk.customer@wernerco.com

🌐 bossacesstowers.com

Werner UK Sales & Distribution Ltd.
is a manufacturer member of:

